

# Product tear sheet

TUBE workstation and table base system

Available as a supply and fit item or supply only stock base components

## STOCK

Height: 720mm, with 25mm thick top  
Lead time: quick ship, 2-3 weeks  
Origin: Taiwan

## MTO

Height: 720mm, with 25mm thick top  
Lead time: 4-5 weeks  
Origin: NSW



# Product tear sheet

## TOP FINISHES:

**Cost effective:** Laminex core commercial melamine range,

**Mid range:** Polytec Ravine or Woodmatt range,

**Premium:** Extended Polytec or Laminex laminate ranges, Painted MDF or plywood with polyurethane finish, Plywood with Forbo Furniture Linoleum range top surface, Veneer

## BASE FINISH:

**MTO:** Dulux or Interpon standard powder coat ranges, black adjustable feet.

**STOCK:** White or black matt powder coat, black adjustable feet.

Stocked modular components are highly flexible and are equally suitable as a workstation and table base.

Low profile beams maximise knee room.

## STOCK COMPONENTS

### Legs:

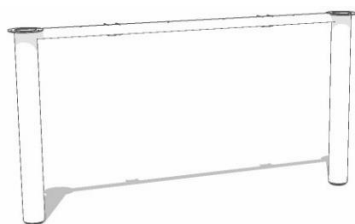

TXL\_end: 1370mm wide end of run leg

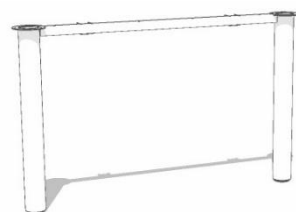

TL\_end: 1170mm wide end of run leg

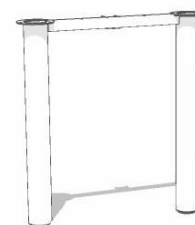

TM\_end: 660mm wide end of run leg

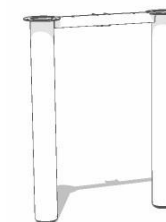

TS\_end: 560mm wide end of run leg

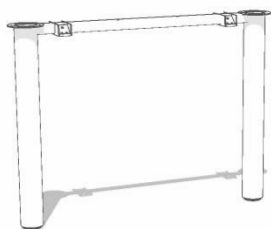

TM\_mid: 970mm wide mid. run leg

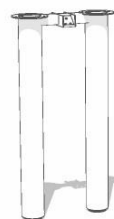

TS\_mid: 360mm wide mid. run leg

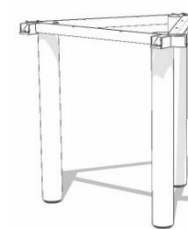

T\_120: snowflake cluster middle leg



T\_post: single post leg



# Product tear sheet

## HOOK Beams:

### ADJUSTABLE:

2400 - 1700 mm (1400 mm beam + 1200 sleeve)

1800 - 1400 mm (600 mm beam + 1200 sleeve)

1600 - 1200 mm (900 mm beam + 750 sleeve)

1300 - 1000 mm (600 mm beam + 750 sleeve)

Adjustability range as measured from centre of connected legs  
Suitable top support and leg connection where length adjustability is required

### FIXED:

1570 mm

1370 mm

1070 mm

770 mm

570 mm

Length as measured from centre of connected legs  
Suitable top support and leg connection where length adjustability is not required

### HOOK PLATE:

Used to make T junction connection,  
For L shape desks or width decrease configurations

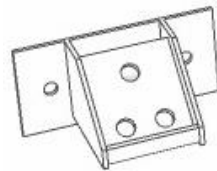

### HOOK HORN:

Creates extended support to top, where beam is not suitable

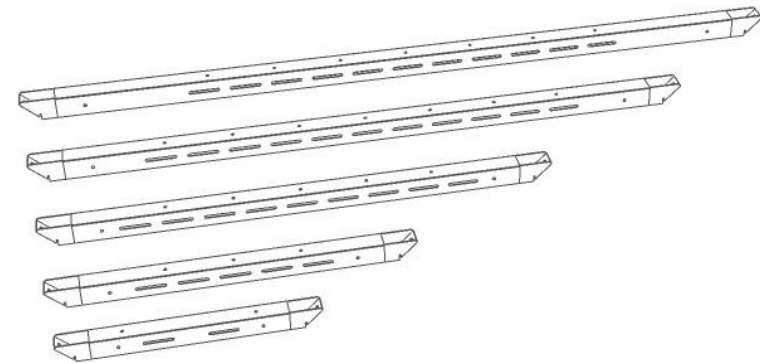
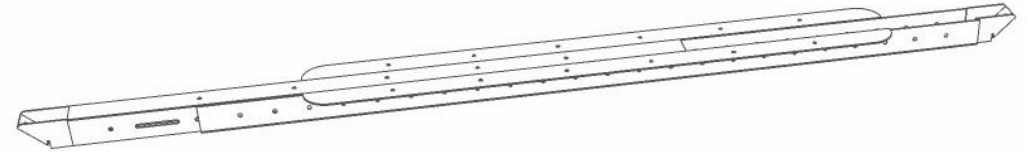
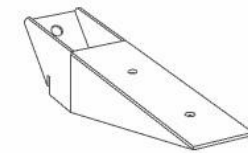

# Product tear sheet

## TOP CONFIGURATIONS:

*Circular table  
or workstation  
cluster*

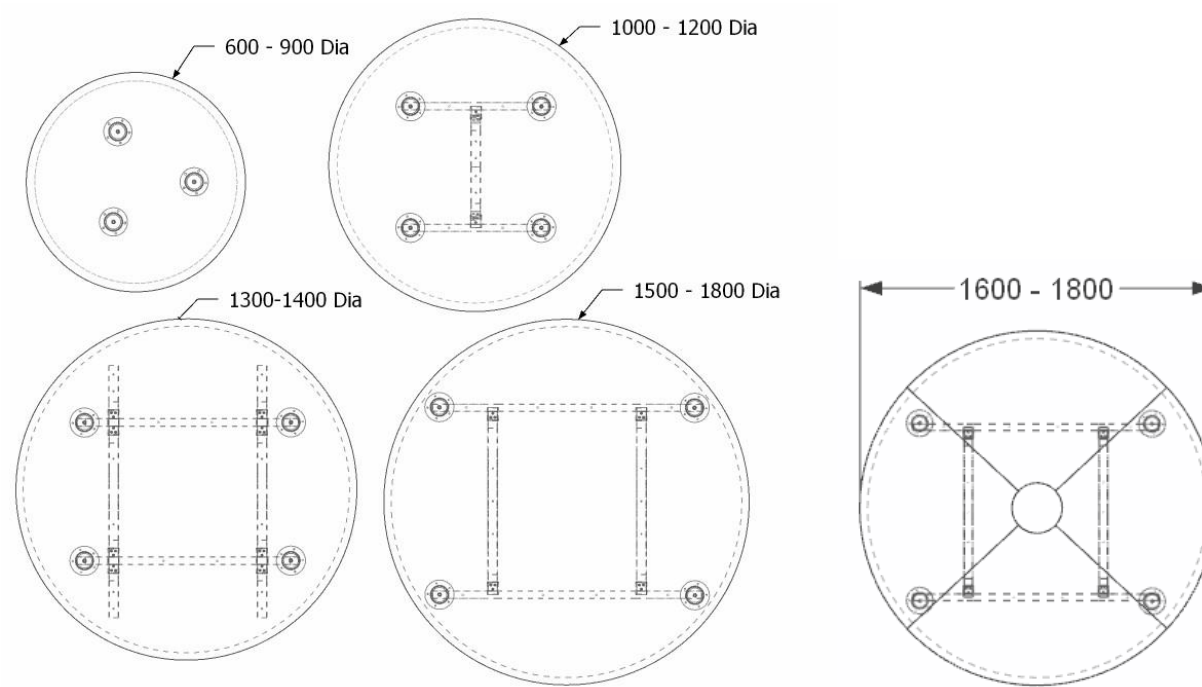

*Square*

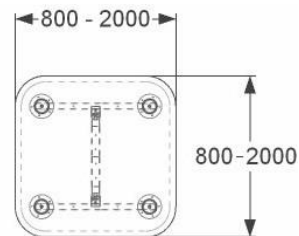



# Product tear sheet

*Rectangular,  
single or  
multiple piece  
tops*

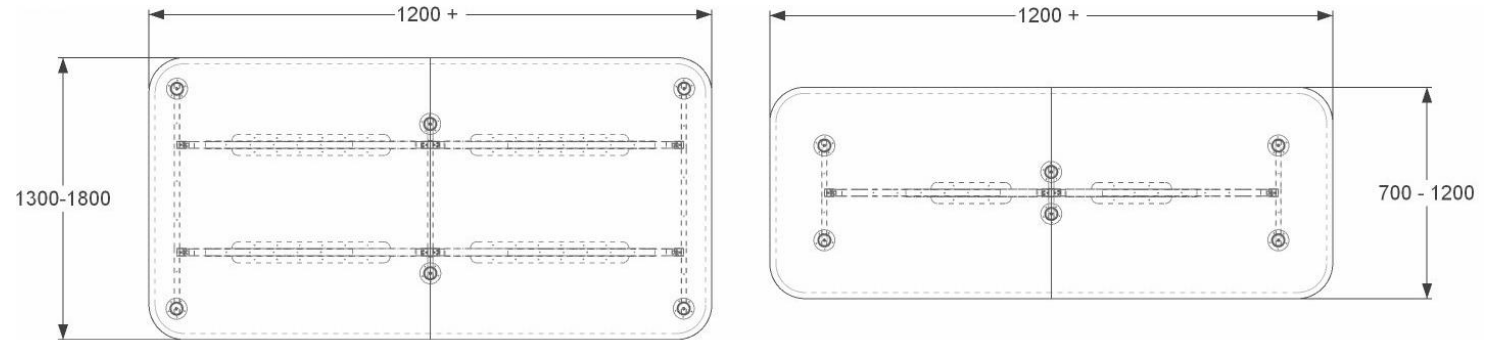

*Regular  
trapezium or  
boat chape,  
single or  
multiple piece  
tops*

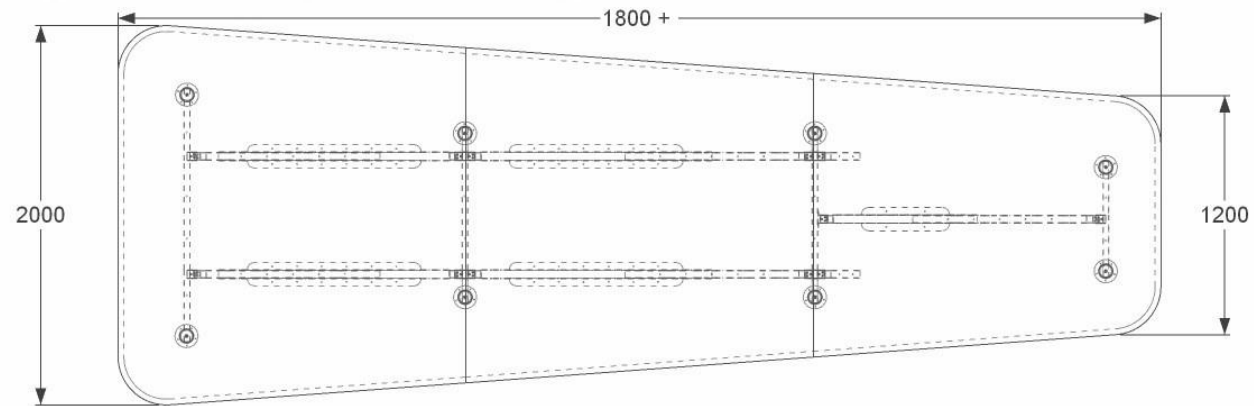

*Linear or L-  
shape desk*

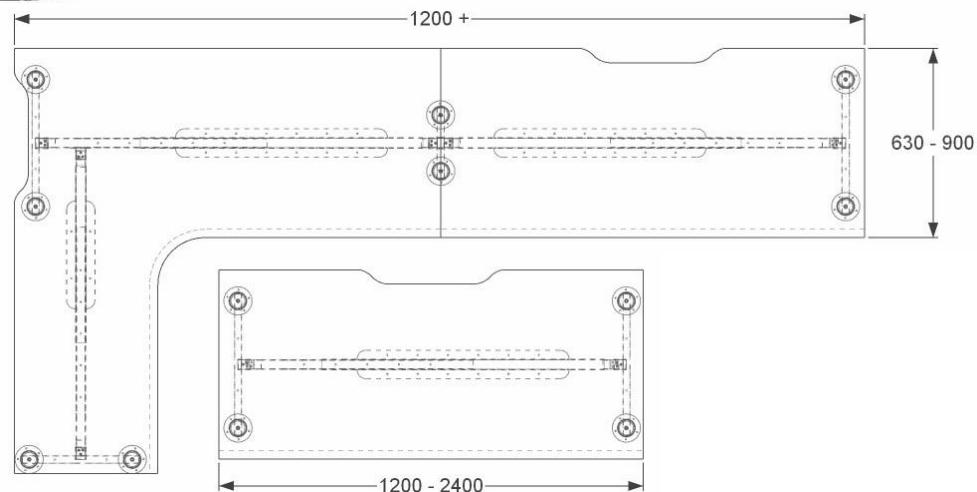

# Product tear sheet

*L-shape or snowflake workstation cluster*

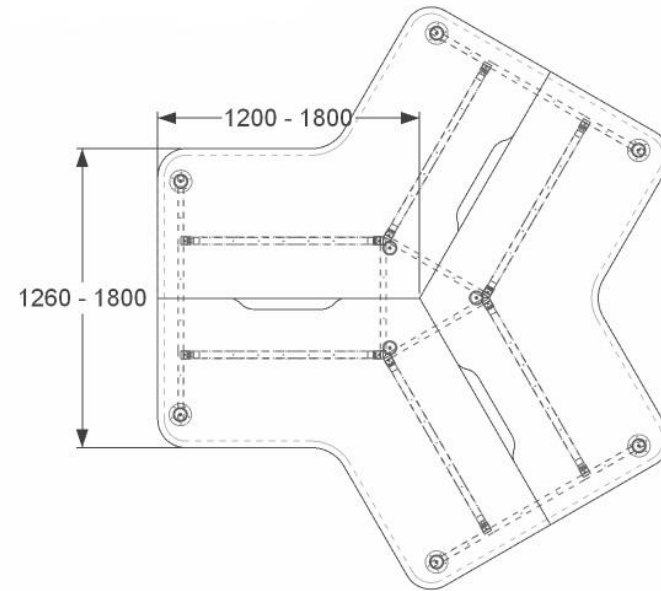
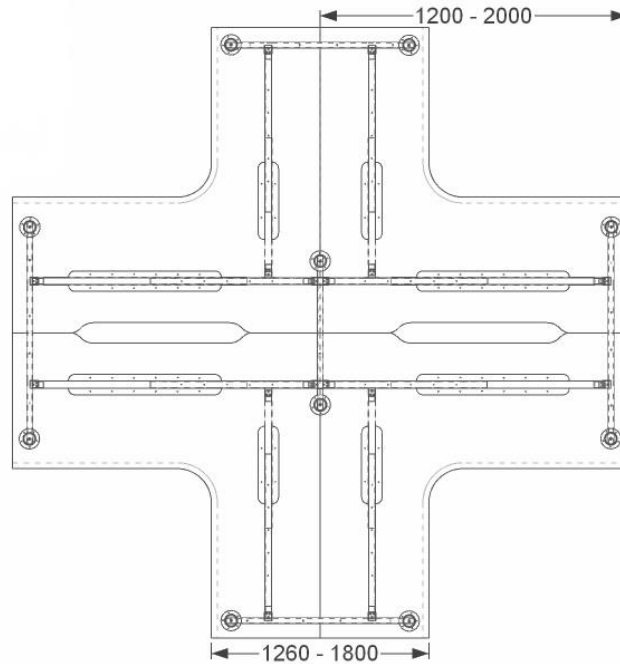

*Linear back to back workstation cluster with meeting end add on*

