



www.klarodesign.com.au

installation guide:
COLUMN

COMPONENTS

includes required fixings

90/60° top plate

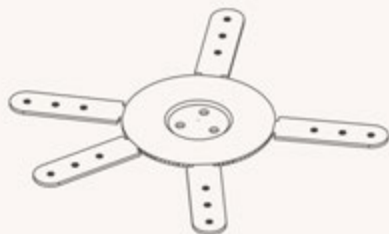

sleeve 400mm

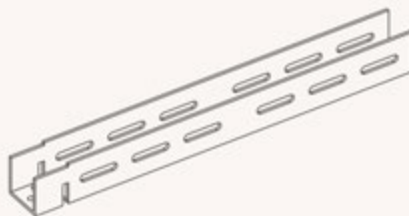

140 Dia leg, 695 or 975mm



beam 2000mm

STEP 1

cut beams and sleeves to required size
ensure 200mm minimum overlap

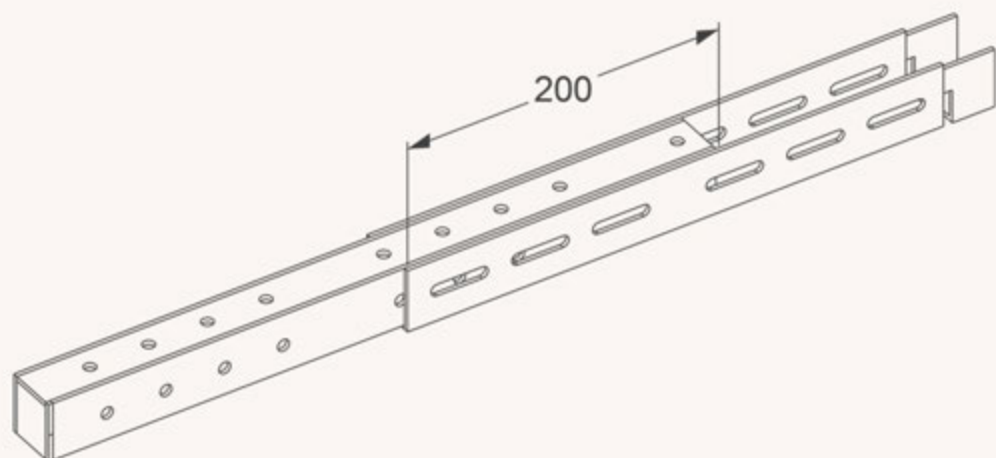
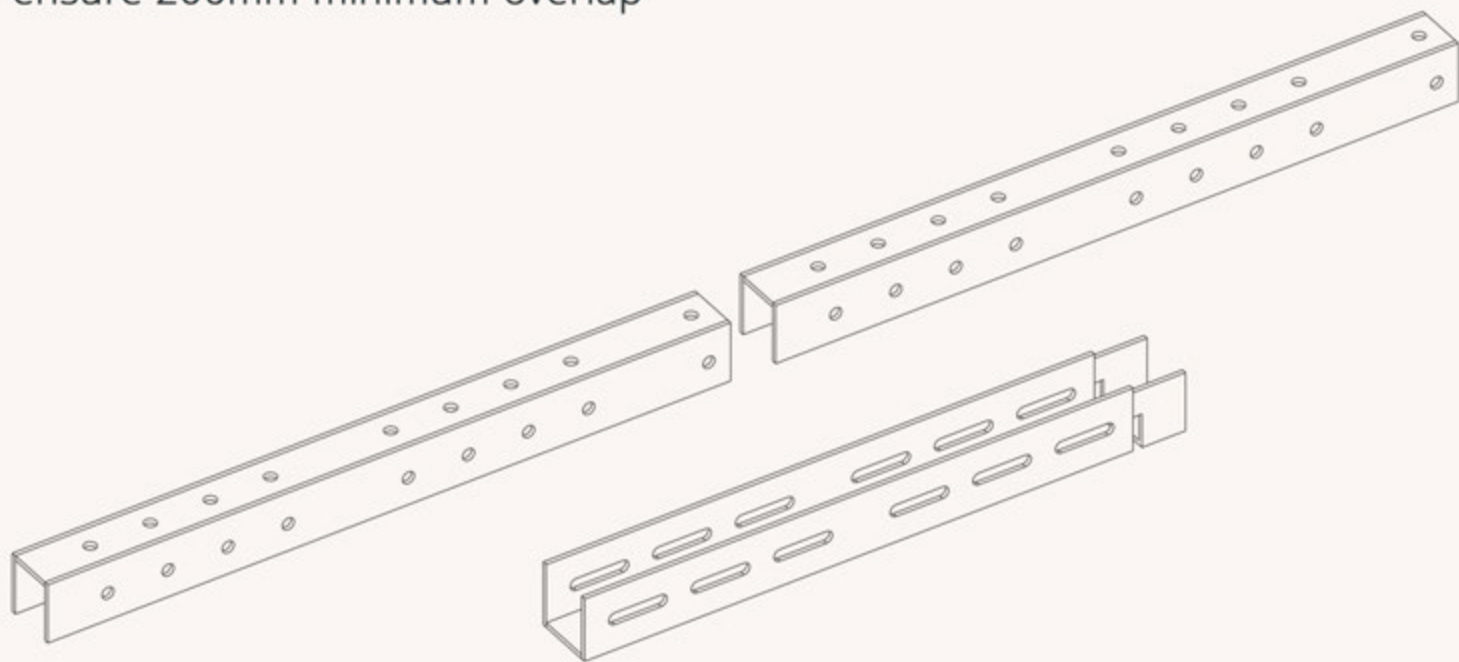

STEP 2

with a help of a rubber mallet, insert the sleeve into a required angle nesting position.

after fixing the sleeve in place, complete the same with the mounting plate, while ensuring tabs are placed within a relevant cut-out to top of the leg.

repeat for each leg, followed by installing beams to achieve required configuration.

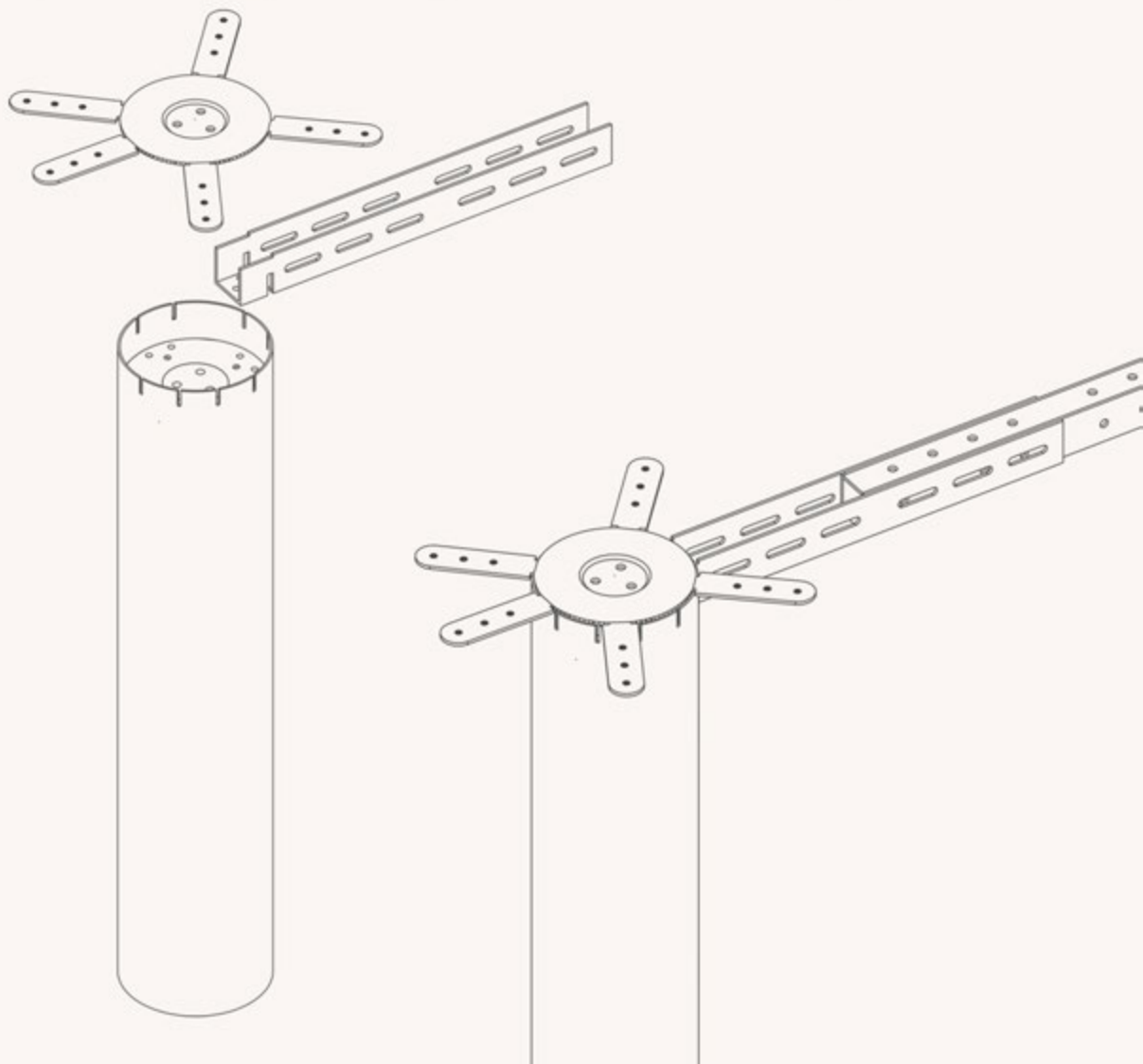

STEP 3

check all leg set outs are correct and all top plate tabs are not overlapping with sleeves

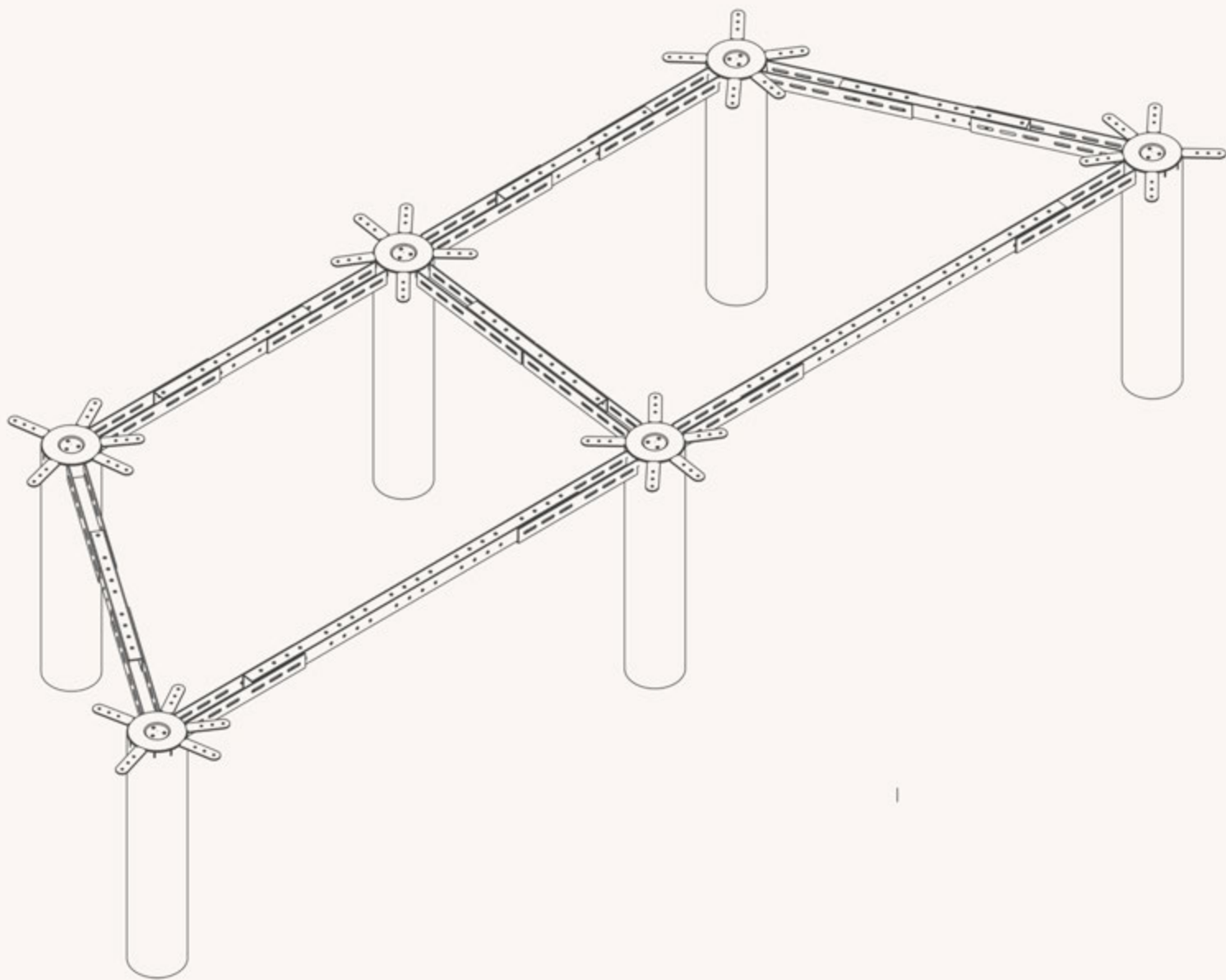

STEP 4

measure out equal over hang and install the top

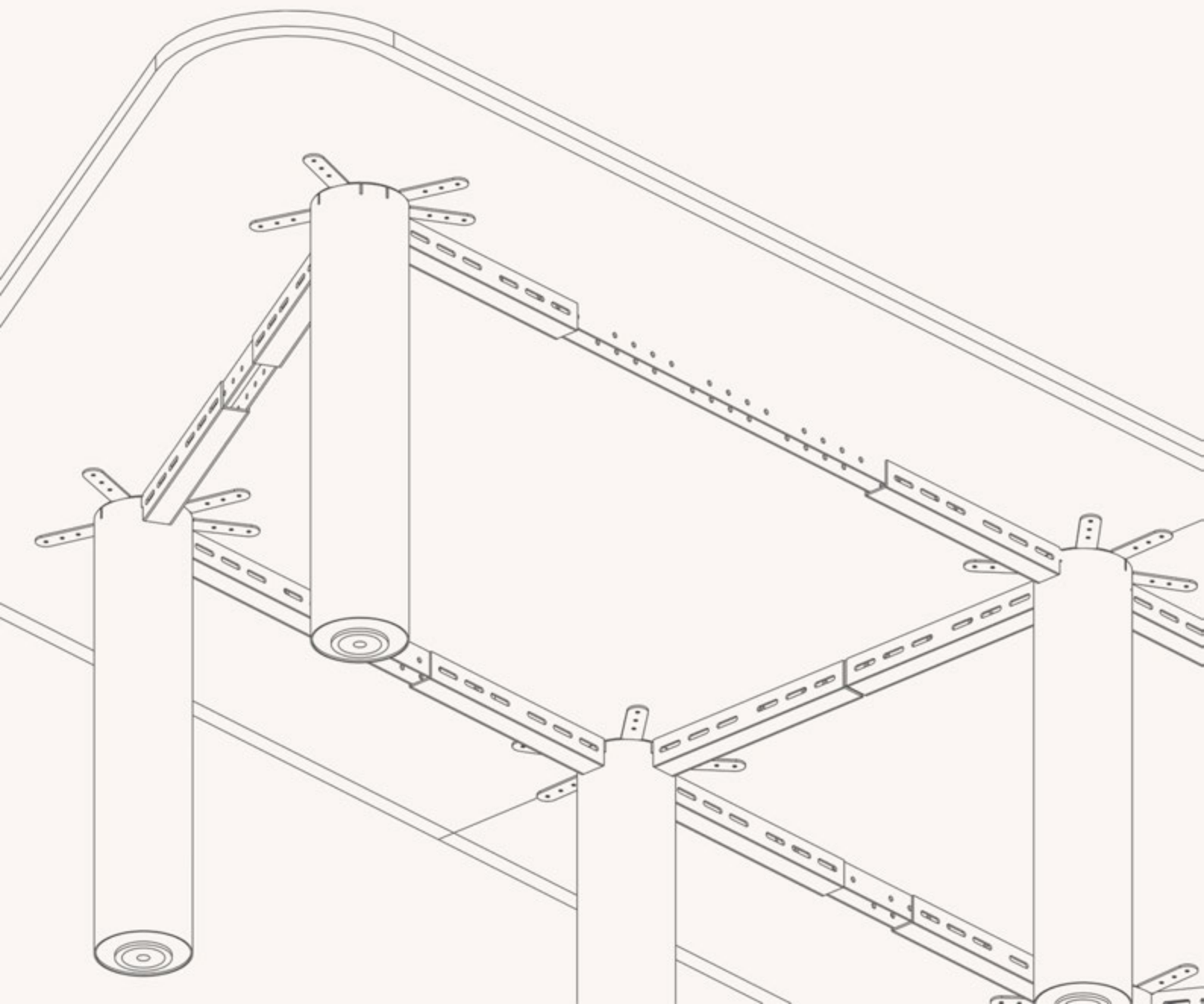

STEP 5

adjust all bench connectors to level out the top join,
wind out or in adjustable feet to level the tabletop and leg position.
if individual legs are not exactly perpendicular to the ground,
leg set out may need to be re-adjusted.

